

f FISON



Vertical Autoclave FM-VA-A100

www.fison.com | info@fison.com

Index

Sr.no	Title	Page no
1.	Safety Measures	2
2.	Introduction	5
3.	Features	5
4.	Specifications	6
5.	Applications	6
6.	Instrument Introduction	7
7.	Installation	8
8.	Operations	9
9.	Maintenance	14
10.	Troubleshooting	16
11.	Accessories	17
12.	Circuit diagram	18

1. Safety measures

 **Alarm:** To ensure the safe use of the device, kindly read the users' manual carefully before starting, each operating procedure should follow the steps that the manual said below, or the damage and danger would be caused by incorrect operation.

Premises:

The manual introduces the operation steps for use, kindly read the MANUAL carefully before the operation to ensure safety.



1.1 Safety instructions

- Kindly read this manual carefully and understand the requirements of all warnings and cautions before using. The users MUST check the safety performance of the autoclave and check if it is in good working condition before using it.
- The autoclave should be used according to the scope of application, use method, and precautions specified in the manual. Otherwise, the unit might be damaged, or sterilization may fail.
- There are some safety protection features equipped with the unit to prevent operators from injury and protect equipment from damage. The operators should understand each step before use.
- Requirements for the operator: The operator must be trained and aware of the equipment's performance characteristics, working principles, and on-site operation, and possess certain knowledge of the sterilization process. Before operation, this manual must be carefully read and understood.
- Requirements for maintenance person: the maintenance person should have corresponding qualifications, professional repair capabilities and familiar experience.
- This equipment is classified as a type I pressure vessel. During use, relevant provisions of the National Pressure Vessel Regulations should be observed. The responsible person should be identified to ensure the safe and correct use of the equipment.
- In the process of designing and manufacturing, we have fully considered the safe use of the product, but the operator still must check and observe the working status constantly, while the equipment is running.
- The connection between the user's network power supply and the power supply should meet the relevant requirements of the national electrical safety standards.
- If the voltage fluctuation exceeds 10%, the equipment cannot work properly.
- Do not use this autoclave next to a strong radiation source (e.g. unshielded RF) which may affect the normal working. It is suggested that the user evaluates the electromagnetic environment primarily to ensure the autoclave functions normally.







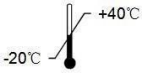

- The replacement of the door gasket is determined according to the frequency of use, the rate of natural ageing, and conditions of cleaning, disinfection, and sterilization. If no damage occurs, the door seals can continue to be used, or they should be replaced in time.
- The equipment and accessories should be used within the specified service life, the overdue use may bring certain safety risks. Due to the aging of the equipment and accessories, there might be some safety risks and hidden dangers at the tail of the service life. Therefore, the equipment safety should be checked every time before use, and the broken spares should be replaced if necessary.
- The disposal of the accessories of this equipment and equipment itself after the service life shall be conducted by the relevant regulations of national and regional environmental protection, and it shall be avoided to pollute the environment or create safety hazards.
- The Safety valves should be regularly tested according to the relevant national regulations.
- MUST disconnect the device before installing a fuse or performing electrical repairs. The fuse for replacement should be of suitable current value. The model, specifications, and current values should comply with the specifications of this manual.
- Confirm the device circuit switch status before operating, so that if a malfunction happens, the device's main power switch should be immediately disconnected.
- To ensure safety and avoid electric shock, ensure that the equipment is properly grounded. Do not modify the grounding protection wire inside or outside the equipment or remove the wiring of the grounding protection terminal. Or the protection function of the equipment can fail and cause a shock hazard.
- MUST pay attention and stay away from the area with hot-proof mark, and exhaust port of the device to avoid burns.

1.2 Explanation of symbols

Some symbols and codes are used on the autoclave's shell in this manual or on the outer carton instead of the text description. The explanation is as follows:

Symbols	Instruction
	Fragile items (the transport package containing fragile items, handling with care)
	Keep Up (the transport package should be straight up during transport)
	Avoid wet (the transport packages should be kept dry)

Vertical Autoclave FM-VA-A100

	Temperature limit (the temperature range during the transport package should be maintained)
	Alternating current
	Protective grounding/ (Protection conductor terminal)
	Disconnect (the main power supply) / (cut (power))
	Switch on (main power) / (connect (power))
	Caution, shock hazard / (electricity danger)
	Caution scalds
	Be careful, Dangerous / (NOTE! See random file)
PT/TT	Pressure/temperature test

2. Introduction

Vertical Autoclave FM-VA-A100 is a top loader sterility autoclave with a 35 L capacity and 134°C sterilization temperature and 0.22 MPa working sterilization pressure. It has hand wheel type quick door open structure design. Equipped with two stainless steel baskets and indicator light to indicate working status of the sterilization process. Designed with four wheels (castors) at base for easy movement of the unit. It provides auto protection against over temperature, over pressure. The chamber is constructed of long lasting 304 grade stainless steel with superior corrosion resistance property. It is CE certified vertical autoclave.

3. Features

- ✓ 304 stainless steel body with hand wheel opening door structure
- ✓ Self-inflated seal type ring to prevent leakage
- ✓ Needle pressure gauge indicator provides an easily readable display
- ✓ Auto protection against over temperature and over pressure
- ✓ Two valves: Drain and inlet valve
- ✓ Light indicator, indicates working status of sterilization process
- ✓ Manual water loading system
- ✓ Safety features for pressure and water deficient
- ✓ Beeping feature for shutting off after sterilization
- ✓ Consists of two stainless steel sterilizing baskets
- ✓ Safe, reliable and user friendly operation mode
- ✓ Comply with strict international directives and standards

4. Specifications

Model No.	FM-VA-A100
Capacity	35 L
Sterilization temperature	134°C
Working sterilization pressure	0.22 MPa
Timer range	0 to 60 min
Control Precision: Temperature	≤ ± 1°C
Digital display	No
Maximum power consumption	2.5 kW
Power supply	AC 220 V, 50 Hz
Chamber dimension (Φ × D)	318 × 450 mm
Dimension (L × W × H)	450 × 450 × 1010 mm
Packaging dimension (L × W × H)	570 × 550 × 1150 mm
Net weight	56 kg
Gross weight	72 kg

5. Applications

It is designed for clinical disposal, biochemistry, pharmaceutical industry, health care industry, fertilizer plant, brewery industry, biotechnology, microbiology and scientific research.

6. Instrument introduction

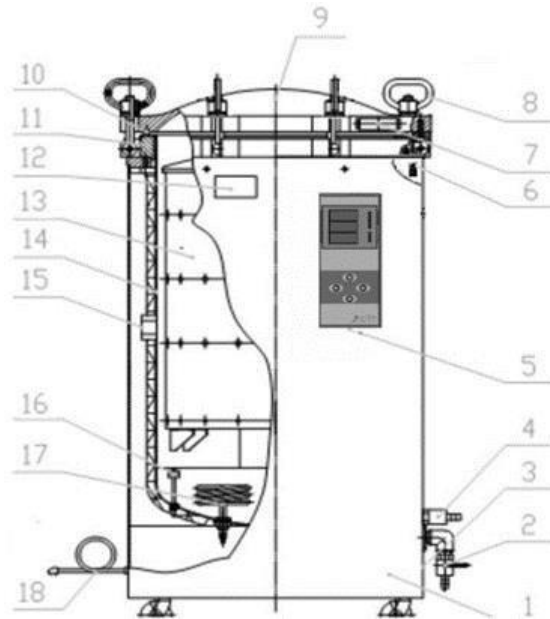

Figure-1

1. Shell
2. Water drain knob
3. Overload power switch
4. Quick change connector
5. Control board
6. Safety valve
7. Handle
8. Tighten bolts
9. Container lid
10. Gasket
11. Flange
12. Nameplate
13. Sterilizing chamber
14. Container
15. PT/TT testing port
16. Low level protector
17. Heating tube
18. Power cord

7. Installation

7.1 The preparation

1) Equipment Placement

- a. The equipment should be placed on a flat surface.
- b. The equipment should be kept at a certain distance from the wall, 30 cm from the left wall, 20 cm from the back wall, and 80 cm from the right wall.
- c. DO NOT place the steam vent of the safety valve too close to the power outlet, and DO NOT block anything.

2) Power connection

- a. **Power requirements:** Single-phase AC 220V $\pm 10\%$, 50Hz
- b. The equipment MUST be reliably grounded. If the outlet has no ground end, the equipment must be grounded with a separate grounding conductor before connecting the power.

Warning:

- a) The power cord must be connected to the power switch for only use. Do not twist or pull the power cord, which might cause damage and looseness to the wires and bring fire hazards or electric shock.
- b) The equipment must be grounded reliably. Do not connect the ground wire to plastic pipes, gas pipes, water pipes, etc.

3) Normal working conditions

- a. **Ambient temperature:** $+5^{\circ}\text{C} \sim +40^{\circ}\text{C}$
- b. **Relative humidity:** $\leq 85\% \text{RH}$
- c. **Atmospheric pressure:** $70 \text{kPa} \sim 106 \text{kPa}$

Note: By using the autoclave, the operator should consider the impact of the local atmospheric pressure on the parameter settings.

Power supply: AC 220V $\pm 22\text{V}$, 50Hz $\pm 1\text{Hz}$.

Note: The water supply should not affect the sterilization process or damage the autoclave or sterilized items.

7.2 The preparation before using

- 1) Check if the power supply parameters are consistent with product requirements.
- 2) After piling the items, place them on a sieve plate sequentially, and leave some appropriate gaps between the packages. We suggest making the packages into 20cm x 20cm x 10cm. The dressing and the textile should not be tightly packed.
- 3) Prepare a sterilizing indicator (chemical indicator or biological indicator).

8. Operations

8.1 The operation instruction

1) The control board instruction

The operation panel is shown in Figure 2.

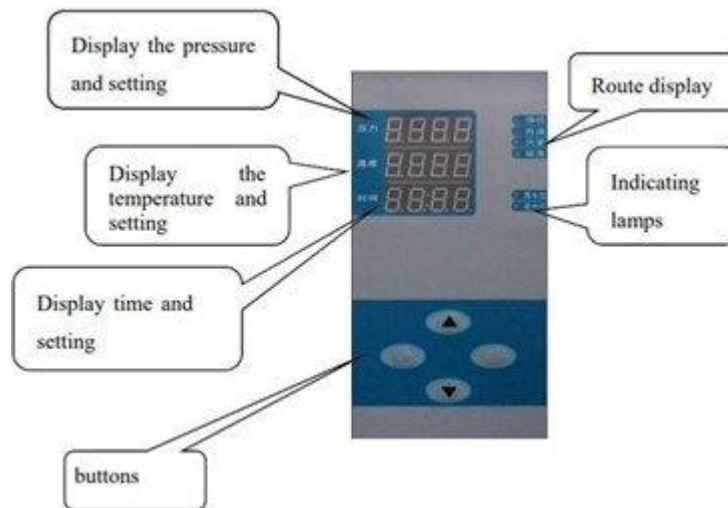

Figure-2

2) Display instruction

- Nixie tube (Upper row)- Pressure display screen (Kpa)
- Nixie tube (Middle row)- Temperature display screen (°C)
- Nixie tube (Lower row)- Time display screen (min)
- Cycle indicates**- Indicate the working cycle of the sterilization cycle Including "standby", "heating", "sterilizing", and "end" four indicators.
- Water level** - Indicating the water level status. Including the "high water" and "low water" indicators. If it is at a low water level, the "low water level" indicator lights. If it is at a high level, the "high water level" indicator lights up. If it is between the high and low water levels, the "low water level" light flashes.

3) Other instructions

- Overload protection power switch**
The lower side of the autoclave, which is used during the equipment is under standby status (see Figure 1).
- Drain knob**
The lower part of the autoclave is used for the discharge of water from the container (see Figure 1).

8.2 Parameter setting the operation

1) The setting

If the unit is on standby (The standby indicator is on), press the SET button, and the second nixie screen will flash, indicating the setting of sterilization temperature, press "▲" "▼" key, to modify the sterilization temperature value. Then press the SET button again, and the third nixie screen flashes, indicating the setting sterilization time, press "▲" or "▼" to modify the sterilization time. Press "SET" again, and the first nixie tube will flash, to set if exhausts or not after the sterilizing, press the "▲" and "▼" keys to modify. Press the SET key again to save the parameter.

C	Minimum value	Maximum valve	Defaults	Remark
Sterilizing temperature	105°C	134°C	132°C	
Sterilizing time	0	599mins	30mins	
Exhaust	0	1	1	0-no exhaust, 1-exhaust

2) Parameter maintenance setting method:

While the unit is on standby, press the "▼" key five times to set the parameters, the below words with color are invalidated, the pressure screen displays the serial number, the temperature window displays the setting value, and press the start button and the serial number scrolls.

P1.	Parameter	Minimum value	Maximum value	Default	Remarks
2	Cold air releasing temperature	100	110	103°C	
3	Cold air-releasing time	0	5	1 second	
4	Cold air releasing Cycle	0	180	60 seconds	
5	The second time for the release of the cold air	0	500	120 seconds	
6	The interval time between two times releasing the cold air	0	600	120 seconds	

Vertical Autoclave FM-VA-A100

13	The temperature for opening the exhausting valve	90	105	102°C	
16	The time limit of the pressure release	1	20	10mins	
21	Pressure compensation	-20.0	20.0	0KPa	
22	Temperature compensation	-20.0	20.0	0°C	
23	If the pressure sensor	0	1	1	0- no, 1- yes
24	Model selection	0	5	0	0-vertical electro-mechanical

8.3 Sterilization work process description

1) Preparation

- a. Open the lid of the container, take out the drums and add water manually till it reaches a high level. (Use distilled water)
- b. Turn on the power and turn on the power brake switch.
- c. The standby indicator light is on. The high-water level indicator lights up.
- d. After piling the items, place them on a sieve plate sequentially, and leave some appropriate gaps between the packages. We suggest making the packages into 20cm x 20cm x 10cm. The dressing and the textile should not be tightly packed. And don't forget to place the sterilizing indicator.
- e. After placing the drum in the container, close and tighten clockwise the hand wheel till the lid is closed. Don't close too tight as it might bring damage to the rubber gasket.
- f. Set sterilization parameters (see parameter settings for details).

The Sterilizing time can be set by the following table, kindly set the sterilizing time and temperature according to the different items required.

Items	Sterilizing time (min)	Pressure (MPa)	Temperature (°C)
Rubber	15	0.1~0.11	121
Textile	15~50	0.1~0.22	121~134
Instrument	8~40	0.1~0.22	121~134
Glassware	10~40	0.1~0.22	121~134
Bottled fluid	20~40	0.145	121~126

a) Heating

Press the START key, the equipment starts to heat. The HEAT indicates the lamp would be on. (Attn: It is only allowed to heat when the water is at a high level).

b) Sterilizing

1. The sterilizing indicating lamp is on.
2. When the temperature of the inner chamber reaches the set value, it starts to time and decreases by "seconds".
When the value of the temperature reaches the setting parameter, it starts to time in a clockwise fashion.

c) End

When the sterilization time is reduced to 0, the transfer is completed, and the internal chamber starts exhausting, the temperature drops and the buzzer sounds when the temperature drops to 102 ° C, indicating that the sterilization is complete. Wait a minute before opening the lid and take out the sterilized item after 20-30 minutes. After opening the lid, turn off the power.

2) Problems with the sterilization cycle

Possible Problems in the Sterilization Cycle

- a. During the sterilization cycle, the operating parameters can be queried.
- b. During the process of sterilization, press the “▲” or “▼” key to reset the program and return the “Standby” status.
- c. When the current is overloaded, the overload protection power switch will automatically cut off the power, eliminate the fault first and then turn on the overload protection power switch again to perform the sterilization operation.
Note: When sterilizing the fluid or the fluid in the glass container, do not exhaust the steam immediately after sterilization is finished. The rapid exhaustion will cause the liquid to boil and overflow, even causing the glass to burst.

8.4 Brief operation steps

- 1) Insert the air faucet into the quick-change connector.
- 2) Connect the power (220V) and turn it on, add the water till the high-level lamp is on (the water floating ball should be immersed in water)
- 3) While the unit is on standby, the parameter could be set as below:
 - a. **Press the SET button:** The second nixie tube flashes to set the sterilizing temperature (132°C~134°C)
 - b. **Press the SET button:** The third nixie tube flashes to set the sterilizing time (for example 30 mins)
 - c. **Press the SET button:** The first nixie tube flashes to set if the air is exhausting after sterilizing.
Press the START button (The equipment defaults to the last mode, it is only required to finish the second step and then directly go to step four to proceed with sterilizing) After sterilizing, it would exhaust the air directly, open the cover when the temperature displays 102°C, then disconnect the power.

Attention:

- a) The exhaust tube should be reliably fixed from both sides.
- b) It is suggested to use distilled water and change the tap water every day.
- c) Read the manual carefully before using it.

9. Maintenance

Precautions and maintenance

Alarm: The operator should observe the relevant provision of The Regulation on Safety Inspection of Special Equipment and Inspection Procedure for Pressure Vessel In use.

- 1) The operator should read carefully this manual before using it, should have operation knowledge and intensify the sense of responsibility, and strictly operate the unit according to the steps of the manual said that is required to do the maintenance below, to ensure the unit is in good condition and normally running, to prevent any accident from happening.
- 2) Ensure there is enough water in the container and keep the water at a high level and the corresponding lamp always on.
NOTE: Too much water would affect the drying of the textile. Before heating, **MUST** strictly follow the provision to eliminate cold air from the container, or the sterilizing result will be affected.
- 3) Don't sterilize different kinds of items at the same time, such as textiles and solutions, rubber and instruments. Otherwise, the sterilizing result would be affected.
- 4) For sterilizing the solution, it should be filled into a glass bottle (or vessel) that is resistant to high temperatures. Caution to not overfill, generally, it is advisable to fill the glass bottle (or vessel) with a volume of 1/2 to 3/4. The bottle mouth should be tightly filled with gauze. Do not use a stopper (such as a rubber stopper or cork stopper) which is without a through hole to fill the bottle mouth. The glass bottle (or vessel) should be placed in a protective container and put into the sterilization chamber, which is important to prevent the glass bottle from bursting or damaging.
- 5) Every day after sterilizing, drain the water from the container. Dry the autoclave and scrub the water stains frequently to ensure the sterilizing result and prolong the service life.
- 6) If there is water incrustation that cannot be cleaned, the following solution is suggested to be used: add 0.75 kg of caustic soda and 0.25kg of kerosene into 10L clean water and mix them. Pour the solution into the container and let it soak for 10-12 hours, then the water incrustation can be cleared and finally rinse with clean water.
- 7) Test the sterilizing temperature, sterilizing time and sterilizing result by the stationary point thermometer, sterilizing indicator or other biological method, to ensure the reliable and best sterilizing result.
- 8) The equipment is a kind of pressure vessel. Must avoid impact during working, and it is forbidden to use overpressure. If the pressure displayed exceeds the maximum allowable value but the safety valve doesn't open to release, the unit should be immediately paused to use.
- 9) The safety valve might fail, kindly check and exchange it. Don't start to use the unit again until the safety valve is qualified. The safety valve should be verified every year at the local Technical Supervision Bureau.

- 10) The gasket is a wearing part, which should be checked frequently. If the feature is changed or deformed or aging hardening, the spares should be changed immediately.
- 11) The replaced fuse should comply with the provision as the manual said, the model and the specification should be the same as the old one.
- 12) Ensure the safety grounding of the unit and ensure the power socket grounding well.
- 13) No special requirement for transportation and storage. If long been, store in a shady, dry and ventilated place, and make the necessary dust-proof work.

10. Troubleshooting

10.1 Common faults and troubleshooting

Faults	Troubleshooting
01	The sensor in the chamber is malfunctioning.
02	The pressure sensor in the chamber is broken.

10.2 Safety features

This autoclave has the following safety features.

Water lacks overheating protection

Water shortage or no water in the container, which would lead to the heating tube being overheated, the autoclave would automatically cut off the power supply by then.

At this point, kindly cut off the power directly. The cover cannot be opened till the pressure inside the chamber is back to zero. Then open the cover, add water into the chamber, close it and screw each of the tightened bolts tightly. Turn on the power brake switch until a high level is displayed, and sterilization can proceed.

Overvoltage Protection

When the inlet line supply voltage is >AC280V, the autoclave will automatically cut off the heating power. At this point, turn off the power and check that the power supply is normal (AC220V) before restarting.

11. Accessories

Accessories no.	Accessories name	Basket capacity	Basket dimension (W × H)	Units
1	Basket	35 L	290 × 190 mm	2

12. Circuit diagram

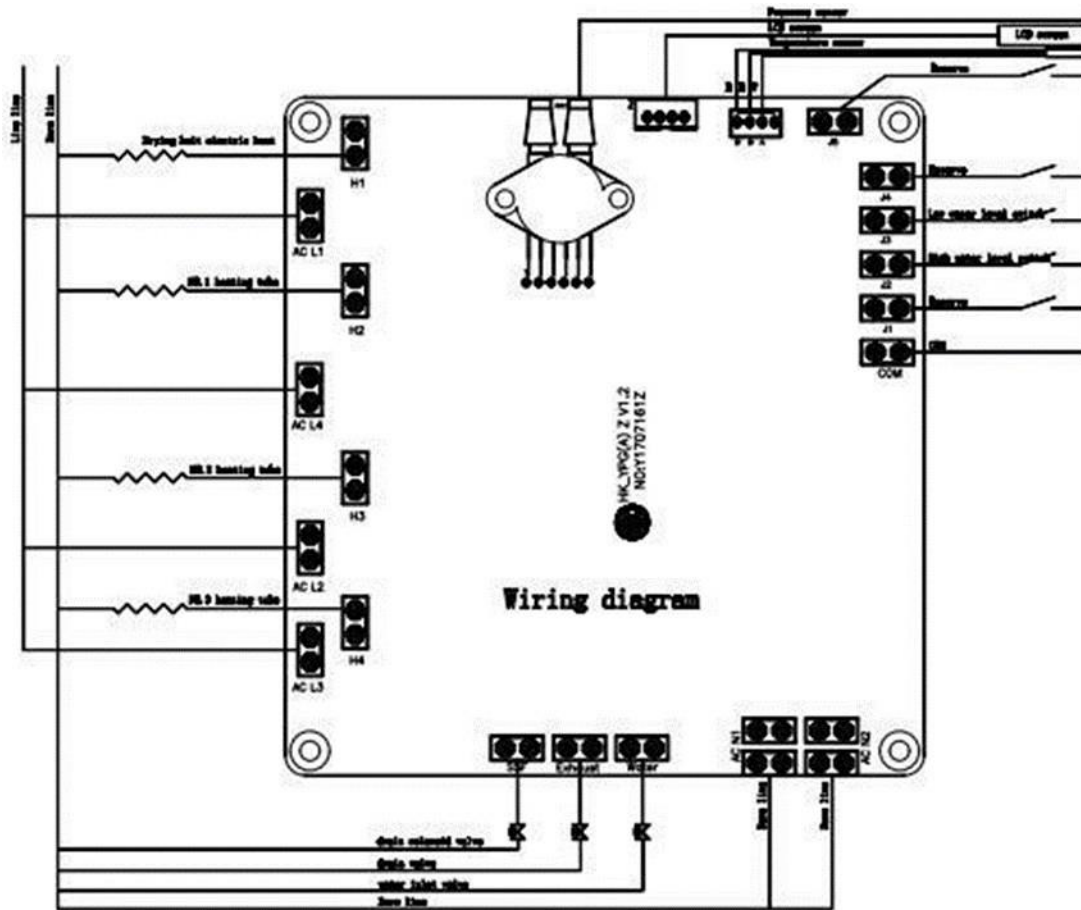

Fison Instruments Ltd

Email: info@fison.com | Website: www.fison.com